

LITTLE FREE LIBRARIES

Studio.0

Brigette Borders & Forrest Jessee

Materials

Poplar Wood
1" x 4" and 1" x 1 1/2"
Pipe Clamps
1/2" Plywood
1" Webbing
3/8" Steel Rod
1/2" Steel Pipe
Polyurethane Spray
1 1/2" Screws
Laser Cut Plexi Doors
Hinges
Wood Glue
1/2" Blocking

Tools

Belt Sander
Rod Bender
Chop Saw
Metal Chop Saw
Table Saw
Portable Drill

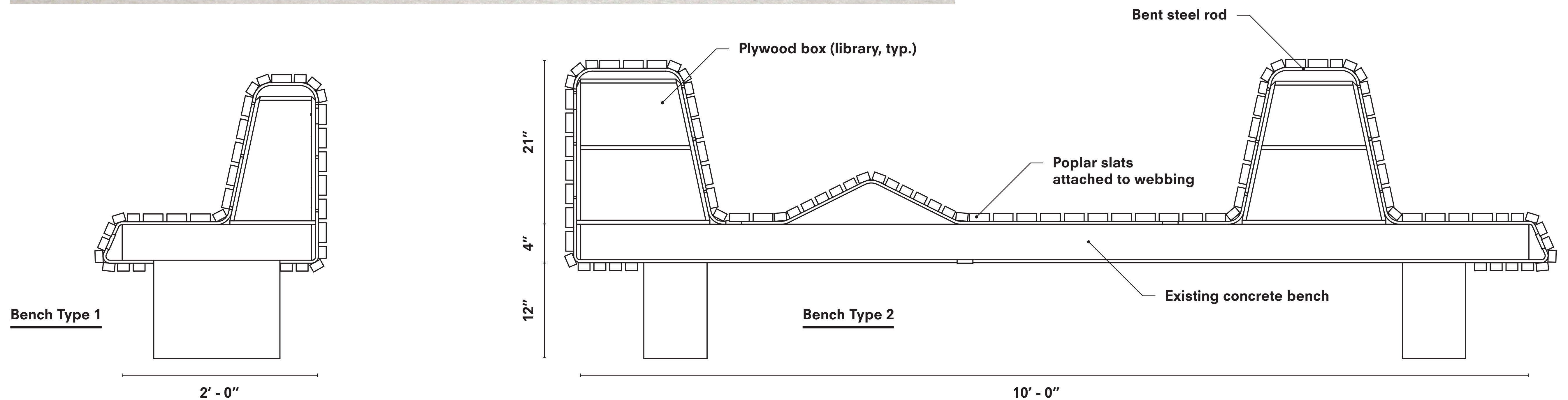

LITTLE FREE LIBRARIES

Studio.0

Brigette Borders & Forrest Jessee

Wooden slats

Poplar strips are cut to bench width (24") and assembled to wrap around the seating structure with 1/4" spacing.

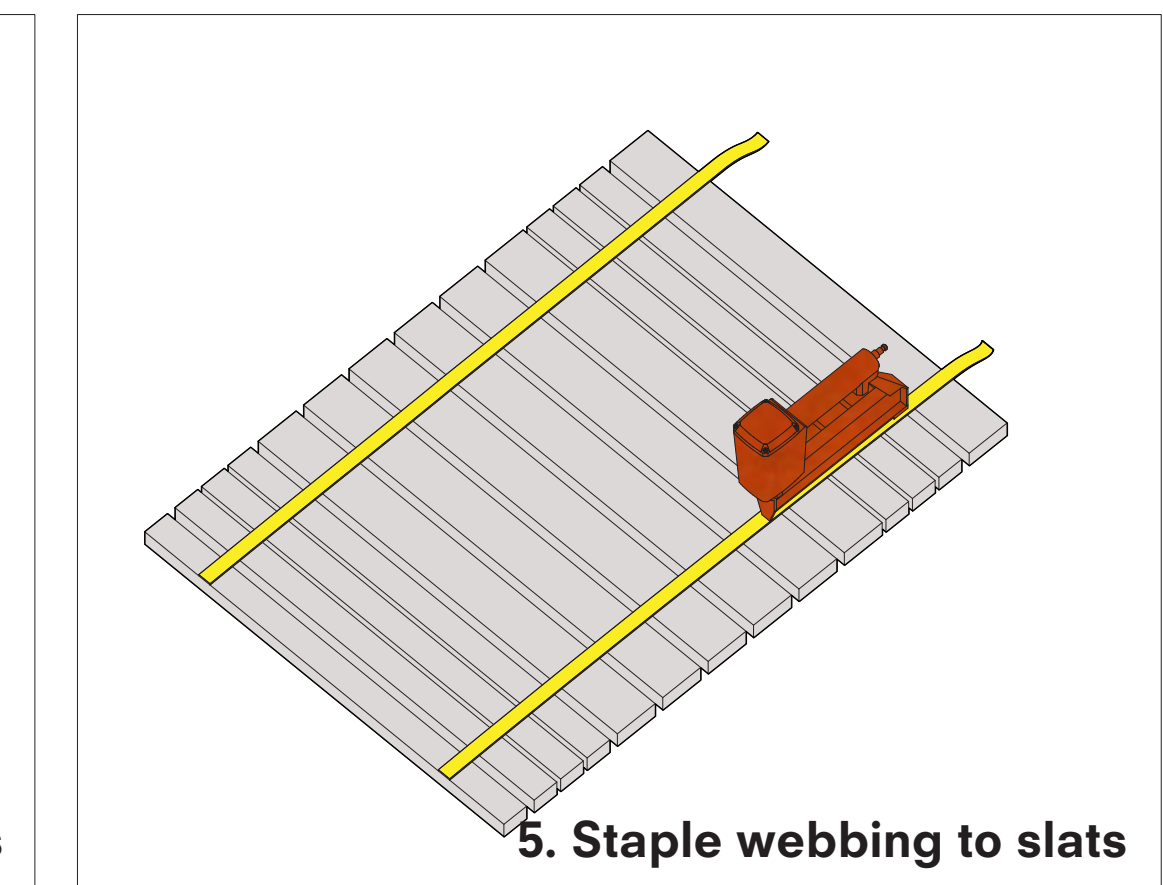
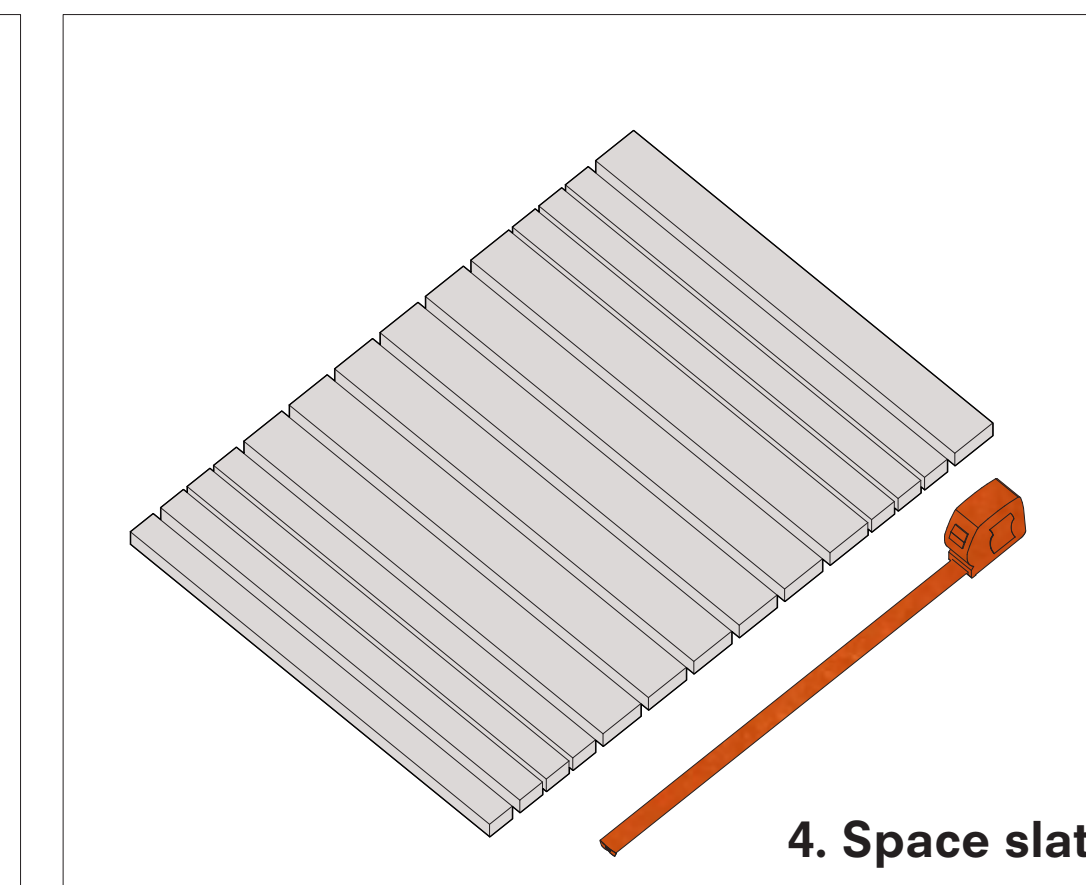
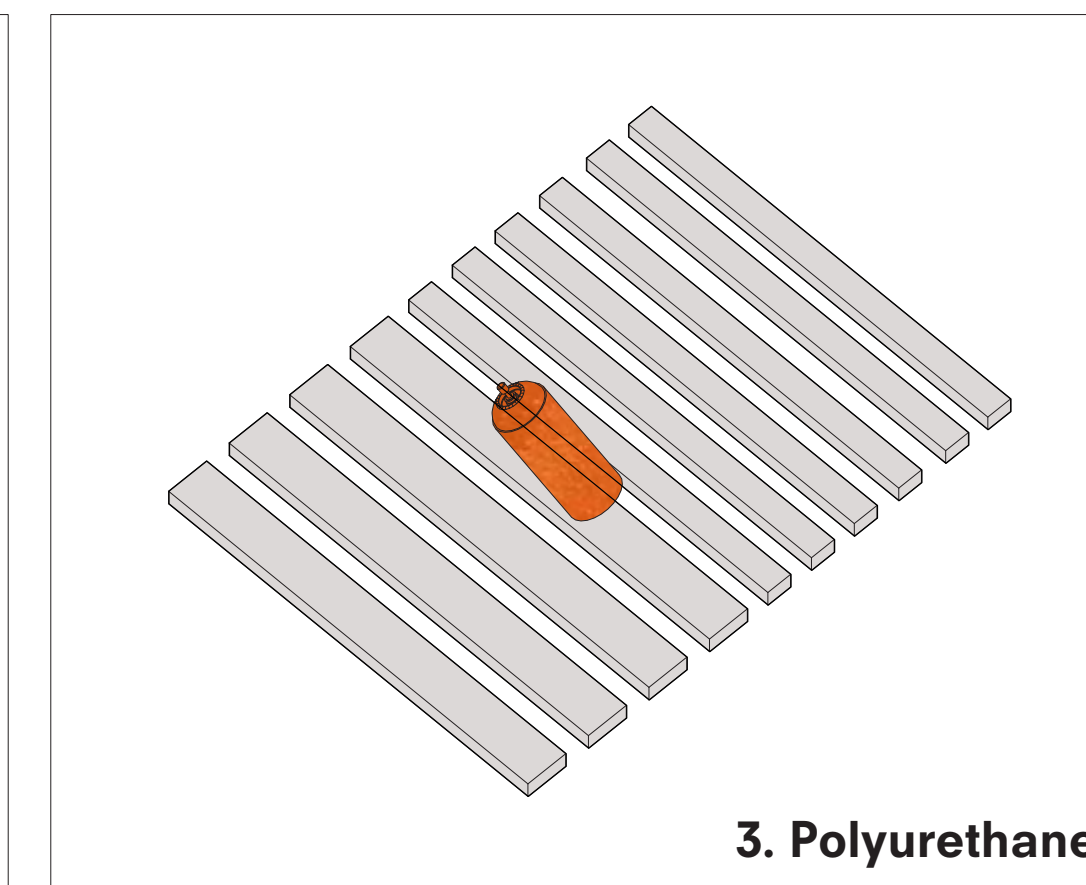
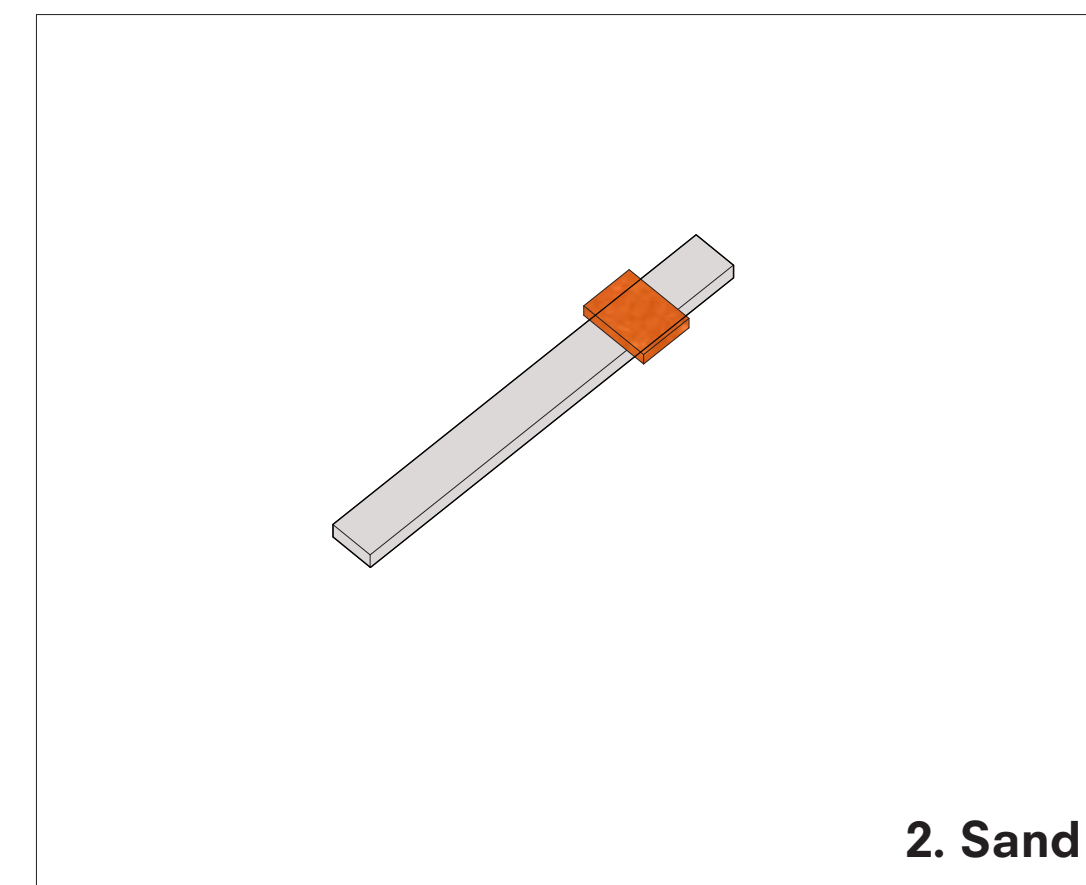

Steel rod frames

Metal rods are bent to 3" and 1" radii in two pieces to match the contour of the bench and provide the seating structure.

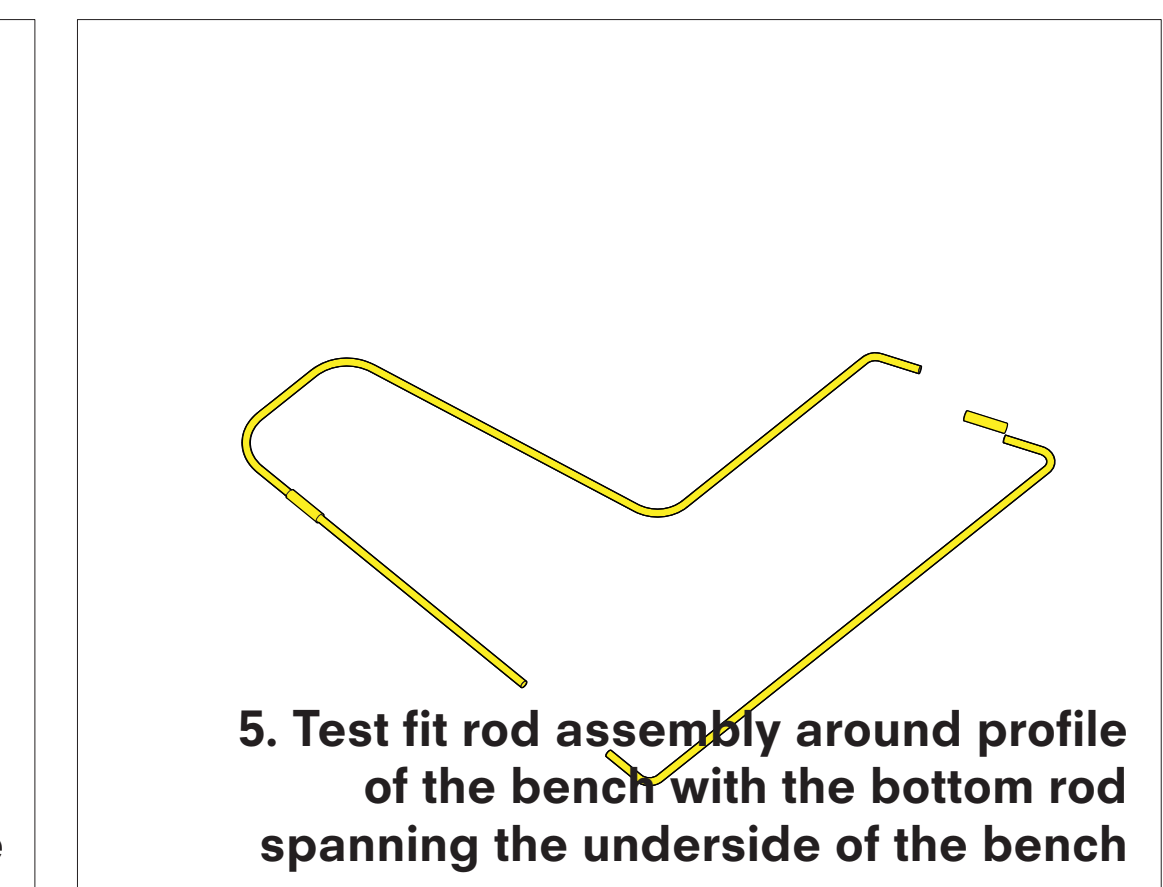
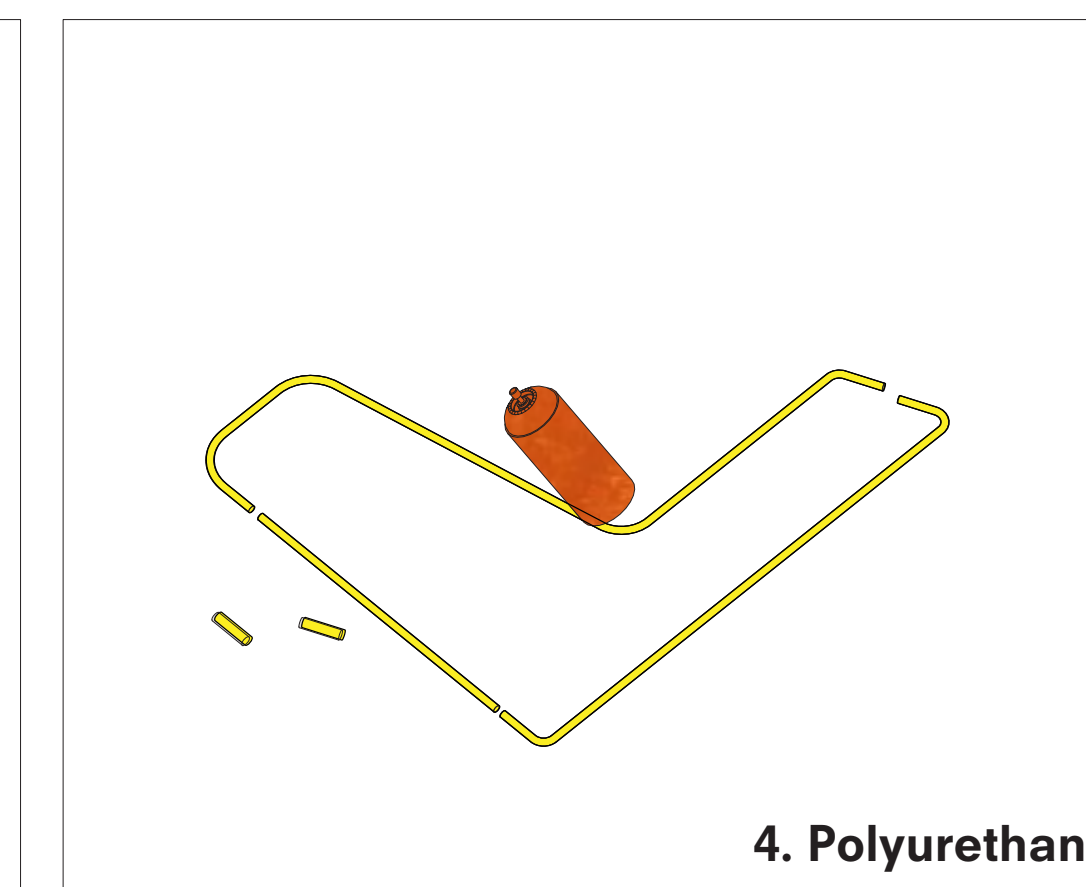
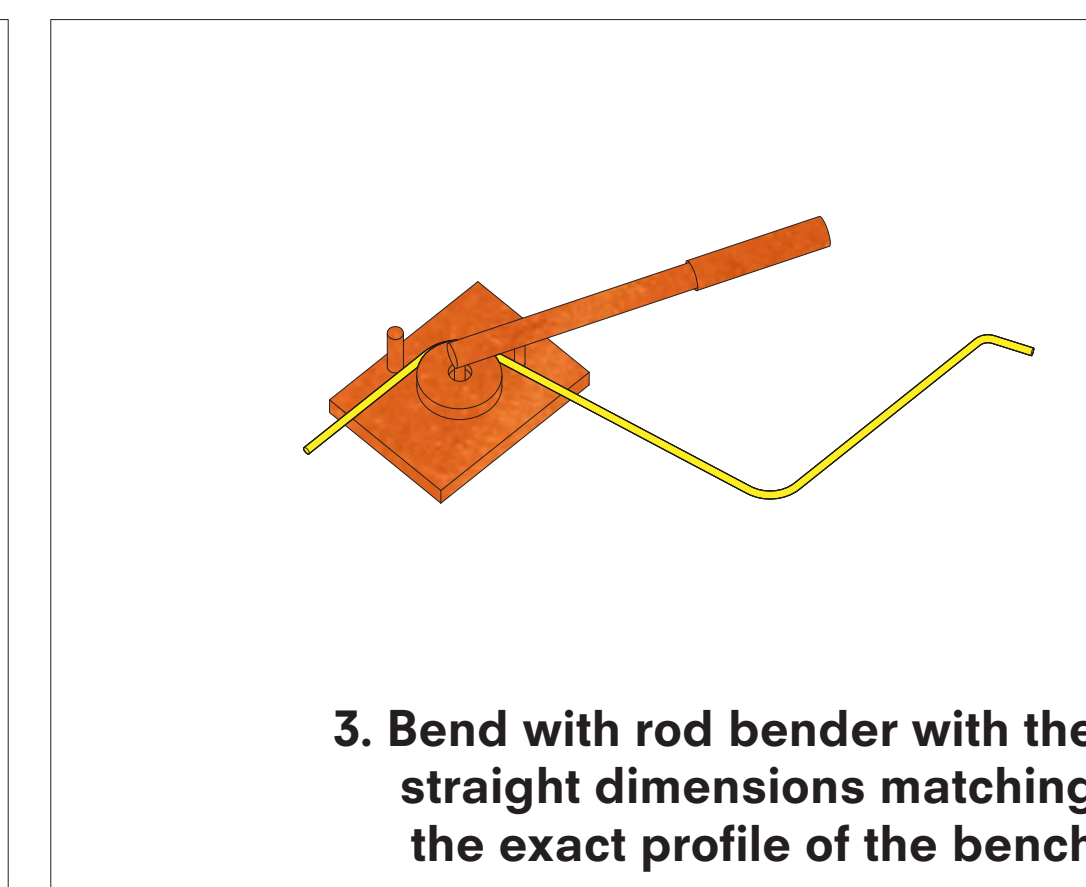
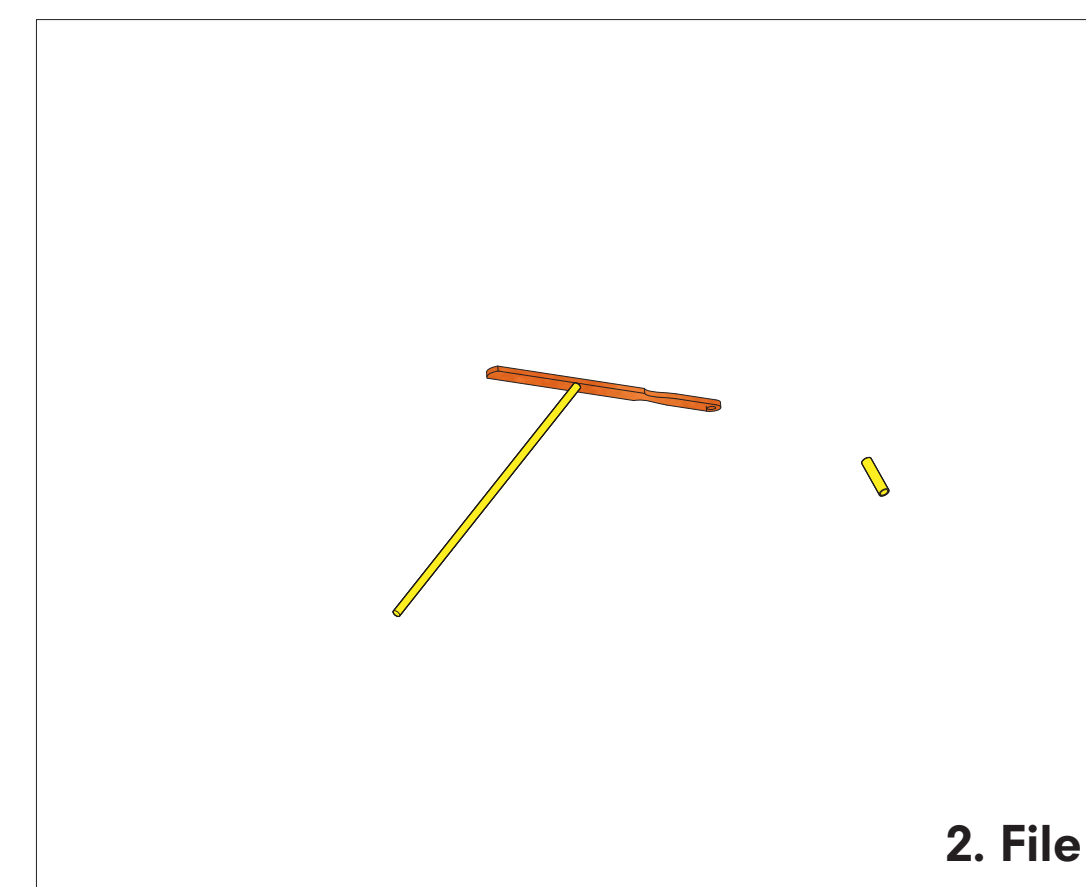
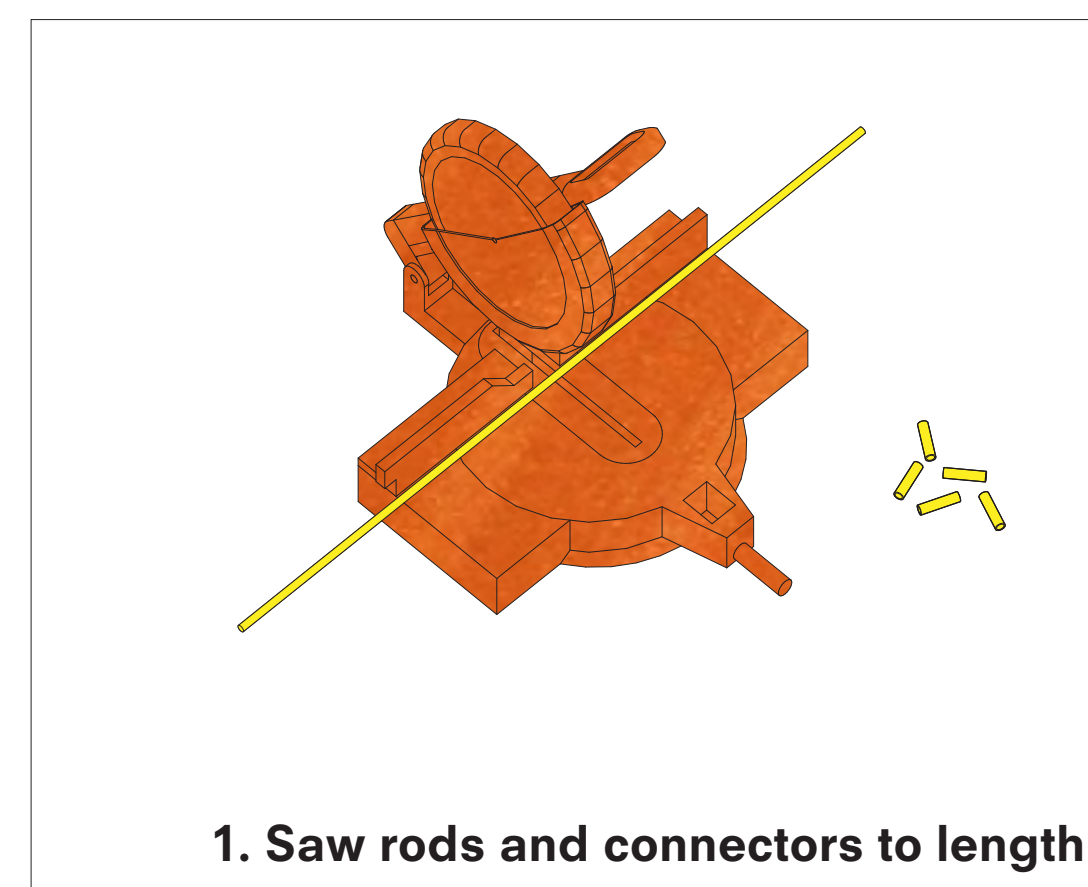

Library boxes

Plywood boxes create both bracing for the seating and housing for the library. Plexi doors are attached with hinges.

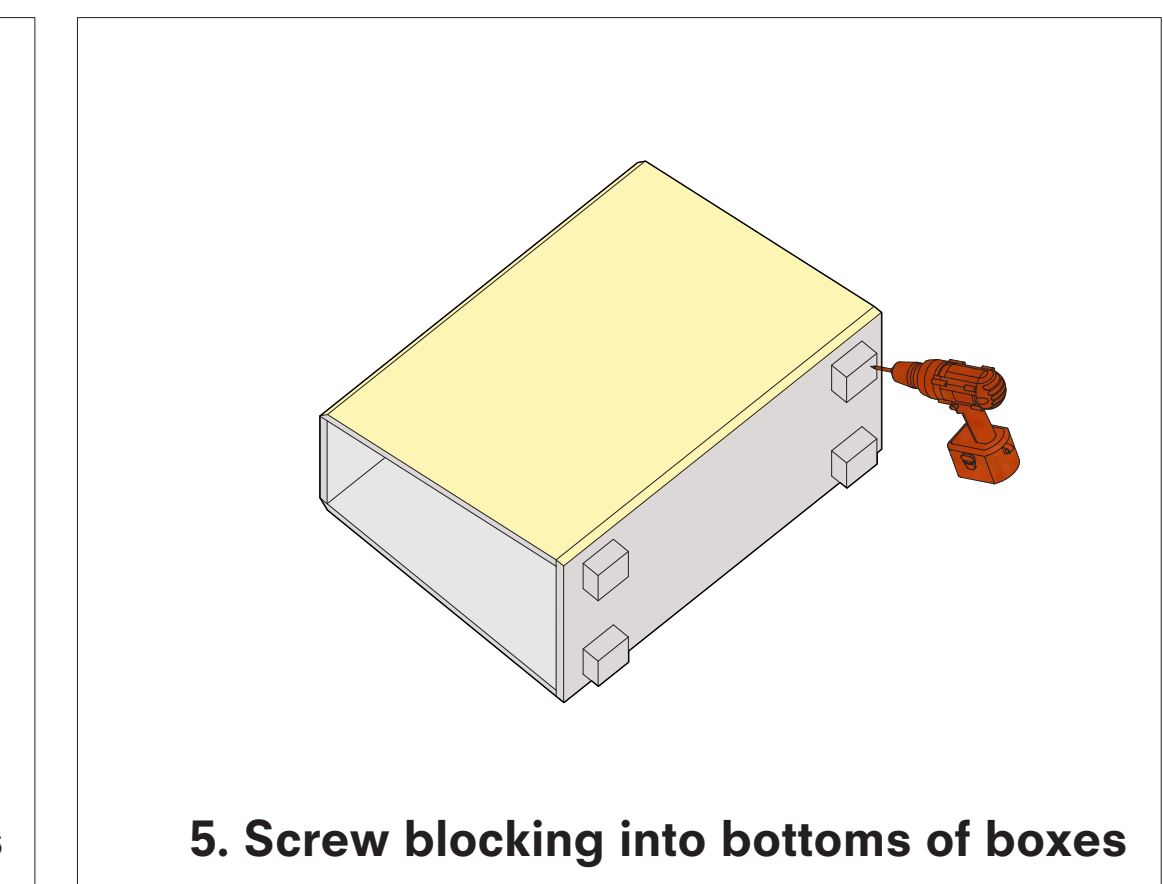
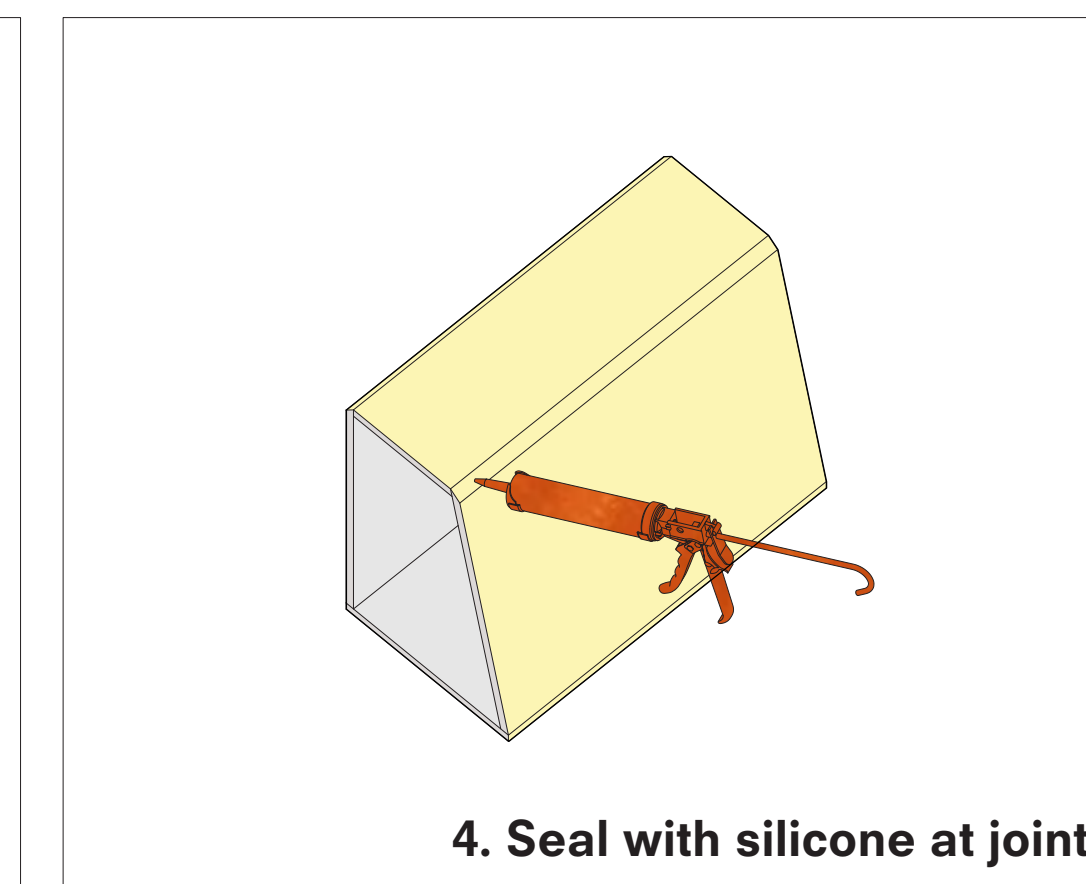
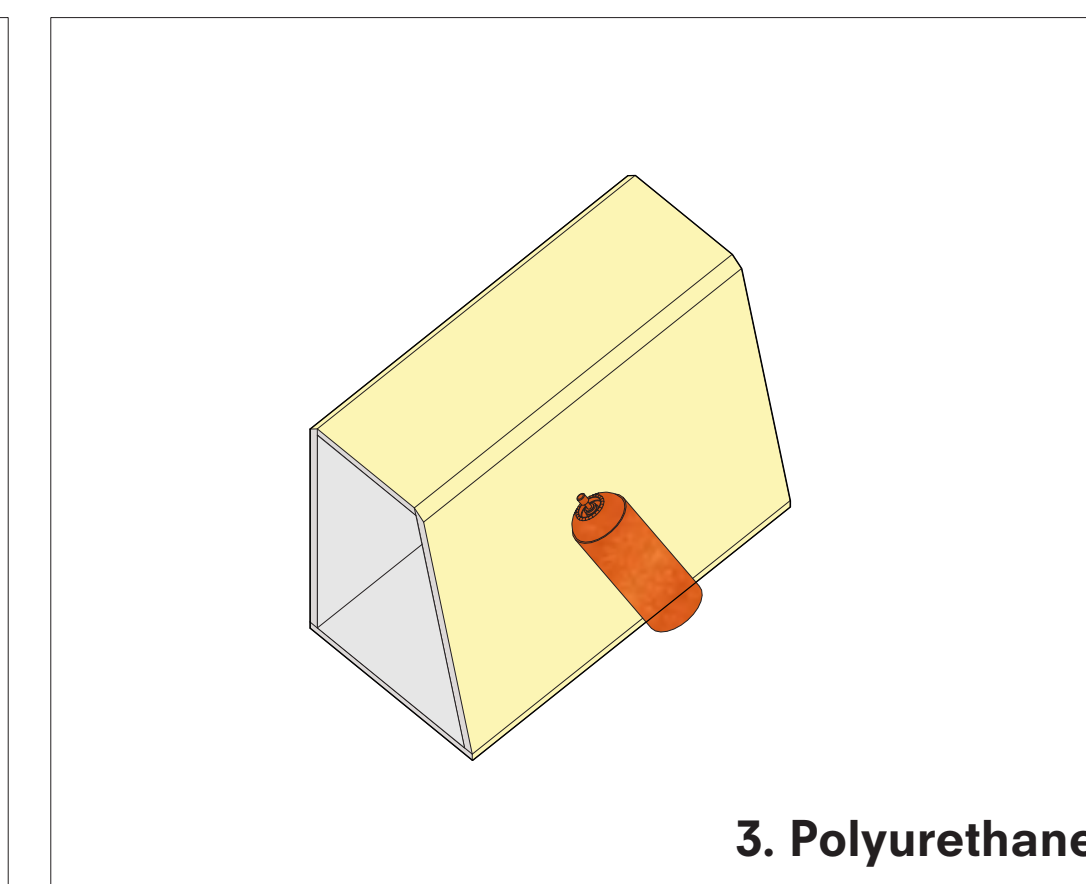
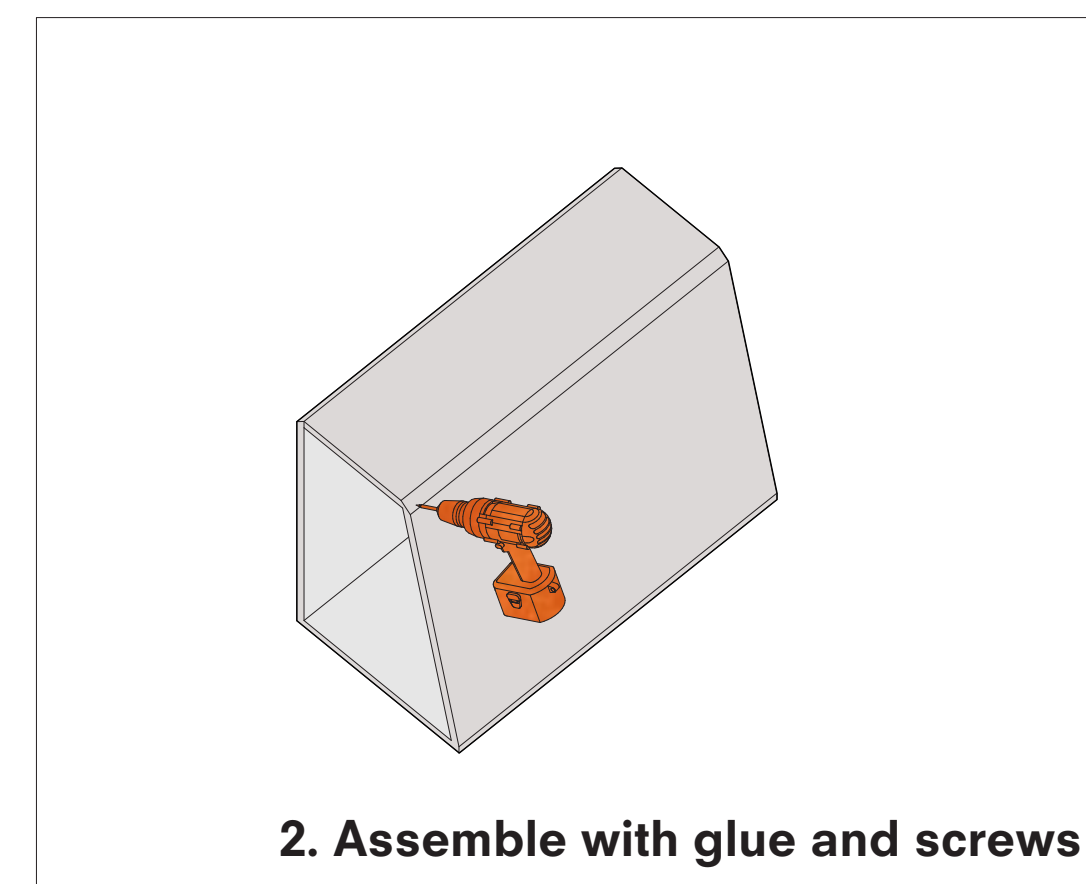

Onsite assembly

The three components can be assembled onsite and are attached to one another using screws and pipe clamps.

